

# Portable Generator

## *P Inverter series*

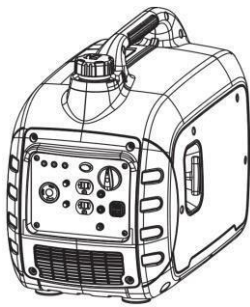

P3000i

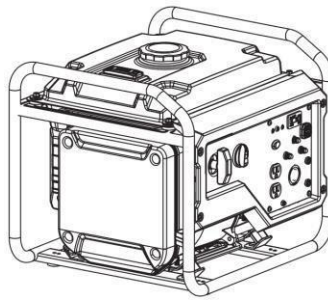

P3500i/O

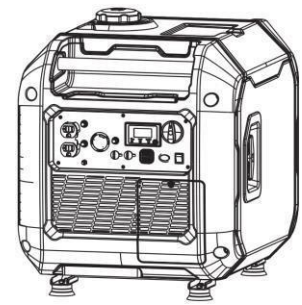

P3500i

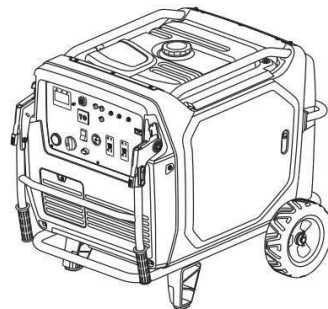

P7500i





Copyright © 2017 PR Industrial s.r.l. – Loc. Il Piano – 53031 Casole d'Elsa (SI)

Printed in Italy All rights are reserved, in particular the world-wide applicable copyright, right of duplication and right of distribution.

This document may only be used by the recipient for the intended purpose. The document may not be reproduced entirely or partially, or translated into any other language.

Reproduction or translation, even extracts thereof, only with written approval of PR Industrial s.r.l.

Any breach of the statutory provisions, in particular the protection of copyright, will lead to civil and criminal prosecution. PR Industrial s.r.l. constantly working on the improvement of its products as part of the technical further development. Therefore, we reserve the right to make changes to the illustrations and descriptions in this documentation without incurring any obligation to make changes to machines already delivered.

Errors excepted. The machine on the cover may have special equipment (options).

**Manufacturer**

PR Industrial s.r.l.

Loc. Il Piano

53031 Casole d'Elsa (SI) - Italy

Tel.: +39 0577965200

E-mail address: [info@pramac.com](mailto:info@pramac.com)

**Original operator's manual**



---

<b>1</b>	<b>Foreword</b>	<b>6</b>
<b>2</b>	<b>Introduction</b>	<b>7</b>
2.1	Means of representation for this operator's manual	7
2.2	PRAMAC representative	8
2.3	Described machine types	8
2.4	Identification of the machine	8
<b>3</b>	<b>Safety Regulations</b>	<b>9</b>
3.1	Safety information in this operator's manual	9
3.2	Description and purpose of the machine	10
3.3	Operational safety	11
3.4	Operator qualifications	12
3.5	Safety when using combustion engines	14
3.6	Service safety	15
<b>4</b>	<b>Safety and information labels</b>	<b>17</b>
<b>5</b>	<b>Standard package</b>	<b>18</b>
<b>6</b>	<b>Lifting and transporting</b>	<b>19</b>
<b>7</b>	<b>Operation</b>	<b>20</b>
7.1	Prepare the machine for first-time application	20
7.2	Accessories Installation (only for P7500i)	21
7.3	Power requirements	22
7.4	Performance loss with high altitude application	23
7.5	Ground	24
7.6	Heavy duty operation	24
7.7	Installation	24
7.8	Use of extension cables	25
7.9	Control Panels	27
7.10	Control Functions	29
7.11	Before starting	33
7.12	Starting the engine	35
7.13	Stopping the Engine	36
<b>8</b>	<b>Maintenance</b>	<b>38</b>
8.1	Period maintenance schedule	38
8.2	Engine oil replacement	39
8.3	Air filter maintenance	40
8.4	Muffler screen and spark arrestor Maintenance	40
8.5	Fuel Filter Maintenance	41
8.6	Spark plug	42
8.7	Battery	42
8.8	Long-term storage	44

<b>9</b>	<b>Basic troubleshooting</b>	<b>46</b>
<b>10</b>	<b>Disposal</b>	<b>47</b>
10.1	Disposal of waste electrical and electronic equipment	47
<b>11</b>	<b>Technical data</b>	<b>48</b>
11.1	P3000i	48
11.2	P3500i	49
11.3	P3500i/o	50
11.4	P7500i	51
<b>12</b>	<b>Diagram</b>	<b>52</b>
12.1	P3000i	52
12.2	P3500i	53
12.3	P3500i/o	54
12.4	P7500i	55
	<b>EC declaration of conformity</b>	<b>56</b>

## 1. Foreword

This operator's manual contains important information and procedures for the safe, proper and economic operation of this PRAMAC machine. Carefully reading, understanding and observing is an aid to avoiding hazards, repair costs and downtime, and therefore to increasing the availability and service life of the machine.

This operator's manual is not a manual for extensive maintenance or repair work. Such work should be carried out by PRAMAC service or by technically trained personnel. The PRAMAC machine should be operated and maintained in accordance with this operator's manual. An improper operation or improper maintenance can pose dangers. Therefore, the operator's manual should be constantly available at the location of the machine.

Defective machine parts must be exchanged immediately!

If you have any questions concerning the operation or maintenance, a PRAMAC contact person is always available.



## 2. Introduction

### 2.1 Means of representation for this operator's manual

#### Warning symbols

This operator's manual contains safety information of the categories: DANGER, WARNING, CAUTION, NOTICE.

They should be followed to prevent danger to life and limb of the operator or damage to equipment and exclude improper service.

---



#### **DANGER**

This warning notice indicates immediate hazards that result in serious injury or even death.

- Danger can be avoided by the following the actions mentioned.
- 
- 



#### **WARNING**

This warning notice indicates possible hazards that can result in serious injury or even death.

- Danger can be avoided by the following the actions mentioned.
- 
- 



#### **CAUTION**

This warning notice indicates possible hazards that can result in minor injury.

- Danger can be avoided by the following the actions mentioned.
- 
- 

#### **NOTICE**

This warning notice indicates possible hazards that can result in material damage.

- Danger can be avoided by the following the actions mentioned.
- 

#### **Notes**

**Note:** Complementary information will be displayed here.

#### **Instructions**

- This symbol indicates there is something for you to do.
1. Numbered instructions indicate that you have to carry out something in a defined sequence.

- This symbol is used for lists.

## 2.2 PRAMAC representative

Depending on your country, your PRAMAC representative is your PRAMAC service, your PRAMAC affiliate or your PRAMAC dealer. You can find the addresses in the Internet at [WWW.PRAMAC.COM](http://WWW.PRAMAC.COM). The address of the manufacturer is located at the beginning of this operator's manual.

## 2.3 Described machine types

This operator's manual is valid for different machine types from a product range. Therefore some figures can differ from the actual appearance of your machine. It is also possible that the descriptions include components which are not a part of your machine.

Details for the described machine types can be found in the chapter *Technical data*.

## 2.4 Identification of the machine

### Nameplate data

The nameplate lists information that uniquely identifies your machine. This information is needed to order spare parts and when requesting additional technical information.

- Enter the information of your machine into the following table:

Designation	Your information
Group and type	
Construction year	
Code no.	
Serial no.	

### 3. Safety Regulations

#### 3.1 Safety information in this operator's manual

This operator's manual contains safety regulations in the categories: DANGER, WARNING, CAUTION, NOTE and COMMENT. These are to be followed in order to reduce the danger of injury, damage to equipment or improper service.



This is a safety warning symbol that warns against possible danger of injury.

- Comply with all safety regulations that follow this warning symbol.



#### **DANGER**

DANGER indicates a hazardous situation that leads to serious injury or death if this warning is not observed.

- In order to avoid fatal accidents and serious injuries, observe all safety instructions precisely that follow this signal word.



#### **WARNING**

WARNING indicates a hazardous situation that can lead to serious injury or death if this warning is not observed.

- In order to avoid possible fatal accidents and serious injuries, observe all safety instructions precisely that follow this signal word.



#### **CAUTION**

CAUTION indicates a hazardous situation that can lead to minor to moderate injury if this warning is not observed.

- In order to avoid possible minor or moderate injuries, observe all safety instructions precisely that follow this signal word.

NOTE: When this word appears without a safety warning symbol, NOTE indicates a hazardous situation that can lead to damage if not observed.

Comment: A comment contains additional important information about a work process.

### 3.2 Description and purpose of the machine

This machine is a portable power source. The portable generator from PRAMAC consists of a frame, which includes a fuel tank, a gasoline engine, a control panel and an electrical alternator. The control panel contains controls and bushings. When the engine is running, the generator converts the mechanical energy into electrical energy. The operator connects electronic loads to the mains sockets.

This machine is used for the electric power supply of connected electric loads. See the product specifications for output voltage and frequency of the generator as well as the maximum power limitation of this generator.

This machine was designed and built exclusively for the aforementioned purpose. Use of the machine for any other purpose could permanently damage the machine or cause serious injury to the operator or other persons in the vicinity. Machine damage due to misuse is not covered by the warranty.

The following practices are considered misuse:

- Connection to an electric load whose voltage and frequency are not compatible with the generator output
- Overloading the generator with a load that takes too much power during continuous operation or when starting
- Operating the generator in a manner that is inconsistent with the national, statewide and local standards and regulations
- Use of the machine as a ladder, support or working surface
- Operation of the machine to carry or transport people or equipment
- Operation of the machine outside of the plant specifications
- Operation of the machine contrary to warning notices attached to the machine and contained in the operator's manual.

This machine was designed and built according to the latest global safety standards. In order to eliminate dangers as much as possible, it was technically designed with great care and contains protective side plates and warning labels for an increased safety of the operator. Additional risks may exist despite these protective measures. These are designated as residual risks. Possible residual risks with this machine:

- Heat, noise, exhaust and carbon monoxide from the engine
- Risk of fire due to incorrect refueling procedure
- Gasoline or gasoline vapors
- Electric shock and arc discharge
- Injury due to incorrect hoisting technology

For your own protection and the protection of other people, make sure that the safety instructions in this manual have been closely read and understood before starting the machine.

### 3.3 Operational safety

---



**DANGER**  
**Carbon monoxide.**

The application of a generator in buildings can LEAD TO DEATH WITHIN MINUTES.

The exhaust fumes from the generator contain carbon monoxide (CO). This is an invisible odorless poison. If the exhaust fumes of the generator can be smelled, CO is being inhaled. Even if no exhaust fumes can be smelled, CO could still be being inhaled.

- NEVER use the generator in buildings, garages, crawl spaces or other partially enclosed areas. Carbon monoxide can build up to deadly levels in these areas. A fan or open window does NOT provide sufficient fresh air.
  - ONLY use generators outdoors and far away from windows, doors and aeration. These openings can draw in generator exhaust fumes.
  - CO can penetrate into a home, even if a generator is used properly. ALWAYS use a battery-powered or battery-backup CO alarm in the home.
  - IMMEDIATELY get to fresh air if you feel unwell, dizzy or weak after using the generator. Consult a physician. It could be carbon monoxide poisoning.
- 



**WARNING**

Electric shock or risk of fire or explosion. Incorrect connection of the generator to a building's mains supply can lead to current being lead from the generator back into the power supply system. This can cause electric shock, serious injury or death of the worker in the public utility company!

- The following connection prerequisites are to be met.
- 



**WARNING**

Battery electrolyte is poisonous and dangerous, causing severe burns, etc. contains sulfuric (sulphuric) acid.

Avoid contact with skin, eyes or clothing.

---

### Connection prerequisites

The following prerequisites are to be met to connect the generator to the building's mains supply.

- The generator must meet the prerequisites with regard to performance, voltage and frequency of the equipment.
- The generator must be disconnected from the electric power supply.
- Connections from the generator to the power supply system of a building must be established by a licensed electrician.
- The electrical connections must meet all laws and electrical regulations.



### WARNING

Prerequisites for safe operation are familiarity with the machine and proper training. Machines that are incorrectly operated or that are operated by untrained personnel may pose a danger. Read through the operating instructions in this manual and in the engine manual to make yourself familiar with the job and the proper use of the operator's controls. Inexperienced operators must be instructed by personnel who are familiar with the machine before they are allowed to operate the machine.

## 3.4 Operator qualifications

Only trained personnel may start, operate and switch off the machine. The personnel must also have the following qualifications:

- be trained in the correct operation of the machine
- be familiar with the necessary safety devices

Access to the machine and operation of the machine is not permitted for:

- Children
- People under the influence of alcohol, drugs or medication

### Personal Protective Equipment (PPE)

The following personal protective clothing (PPE) is to be worn when operating this machine:

- Close-fitting work clothes that do not impede movement
- Safety glasses with protective sides
- Ear protection
- Work shoes or boots with toe protection
- NEVER use generator near open containers of fuel, paint or other flam-mable liquids.
- NEVER touch the generator or tools connected to it if you have wet hands.
- NEVER use damaged power cables. Electric shock and major machine damage could occur.
- NEVER place power cable below the generator or on vibrating or hot parts.
- NEVER cover hot or running generator.

- NEVER overload generator. The total amperage of the parts connected to the generator may not exceed the output limit.
- NEVER operate the machine in snow, rain or standing water.
- NEVER allow untrained personnel to operate or maintain the generator. Familiarize yourself with the operation and shutdown before starting the generator.
- ALWAYS store the machine properly when not in use. Store the machine in a clean dry place and keep it out of reach of children.
- ALWAYS make sure that the machine is stable and cannot tip, roll, slide or fall during operation.
- ALWAYS transport the generator in an horizontal position.
- ALWAYS keep at least one meter distance from facilities, buildings or other machines while operating the machine.
- ALWAYS keep the area immediately around and under the machine clean, tidy and free of grime and flammable materials. Check that there is also no grime above the machine that could fall onto or into the machine or the exhaust area.
- ALWAYS keep all tools, power cables and other loose objects away from the generator before starting.
- Do NOT ground this generator.
- If more than one electric device is connected to the generator, the additional connected electric equipment must be connected to the generator via an isolating transformer or a suitable FI switch (PRCD), whereby each additional electric device must be operated via a separate isolating transformer or PRCD.

### **Generator vibration**

Generators vibrate during normal operation. Check during and after use of the generator whether the generator or the extension cord and power cable show damage due to vibration.

- Repair any damage as needed or replace the parts affected.
- Do not use any plugs or cables that show signs of damage, such as damaged or cracked insulation or blades.

### 3.5 Safety when using combustion engines

**WARNING**

Combustion engines pose a particular danger during operation and when refueling. Failure to follow the warning notices and safety standards can lead to serious injury or death.

- Read and always observe the warning notices in the operator's manual of the engine and the safety instructions below.

**DANGER****Carbon monoxide.**

Use of the generator in buildings can LEAD TO DEATH WITHIN MINUTES. The exhaust fumes from the generator contain carbon monoxide (CO). This is an invisible odorless poison. If the exhaust fumes of the generator can be smelled, CO is being inhaled. Even if no exhaust fumes can be smelled, CO could still be being inhaled.

**WARNING**

Never smoke or make and break connections at the battery while charging. Sparks may ignite the battery gas.

#### Operational safety

When running the engine:

- Keep the area around the exhaust pipe free of flammable materials.
- Inspect the fuel lines and fuel tank for leaks and cracks before starting the engine. Do not operate the machine if there are leaks or if the fuel lines are loose.

When running the engine:

- Do not smoke while operating the machine.
- Do not operate the engine near sparks or open flames.
- Do not touch the engine or the muffler while the engine is running or shortly after switching the engine off.
- Do not operate the machine with a loose or missing fuel cap.
- Do not start the engine if fuel has been spilled or there is an odor of gas. Move the machine away from the spilled fuel and wipe away the spilled fuel before starting.



### Safety when refueling

When refueling the machine:

- Immediately wipe away any spilled fuel.
- Fill the fuel tank in a well-ventilated area.
- Reattach the fuel tank cap after refueling.
- Do not smoke.
- Do not refuel hot or running engines.
- Do not refuel the engine near sparks or open flames.
- Do not refuel the machine while it is on plastic-coated surfaces of pick-ups. Static electricity can ignite the fuel or fuel vapors.

### 3.6 Service safety

---



#### **WARNING**

Carelessly maintained machines can pose dangers! Regular maintenance and occasional repairs are necessary to ensure the safe and correct functioning over longer time periods. If problems should occur with the generator or while the machine is being maintained, always attach a "DO NOT START" sign to the control panel in order to alert others of this.

---

#### **Personal Protective Equipment (PPE)**

Wear the following personal protective equipment during maintenance or repair work:

- Close-fitting work clothes that do not impede movement
- Safety glasses with protective sides
- Ear protection
- Work shoes or boots with toe protection

Additional notes before operating the machine:

- Tie up long hair
- Take off all jewelry (including rings)
- Do NOT use any gasoline or other types of fuel or flammable solvents to clean the machine parts, especially not in closed areas. The vapors from fuels and solvents may explode.
- NEVER operate equipment without protective devices or with damaged protective devices.
- NEVER modify the machine without written approval from the manufacturer.
- NEVER allow water to collect at the bottom of the generator. If water should collect, remove the generator and allow it to dry thoroughly before maintaining.
- NEVER maintain the machine with wet clothing or wet skin





- NEVER have the machine serviced by untrained personnel. Electric elements of this machine should only be maintained by qualified electricians.
- NEVER allow children to approach the machine. Keep always a safe distance between children and the generating set.
- ALWAYS keep the machine clean and ensure that the labels are legible. Replace all missing and hard-to-read labels. The labels contain important operating instructions and warn against dangers.
- ALWAYS reattach protective devices and safety equipment to the unit after repair and maintenance.
- ALWAYS allow the engine to cool completely before transport.
- ALWAYS watch out for the rotating parts of the generator and engine and keep hands, feet and loose clothing parts away from these rotating parts.
- ALWAYS switch the engine off before maintenance. Disconnect the negative connection of the battery on machines with electric starters.
- ALWAYS keep fuel lines in a good condition and connected correctly. Leaking fuel and gases are highly explosive.
- If spare parts are required for this machine, only use parts from PRAMAC or parts that match the original exactly in terms of dimensions, model, intensity and material.

## 4. Safety and information labels

There are labels on your equipment that contain important information and safety instructions.

- Keep all labels legible.
- Replace missing or illegible labels.

The item numbers on the labels can be found in the parts book.

Item	Label	Description
1		Guaranteed sound power level.
2		<p><b>DANGER!</b> Danger of suffocation.</p> <ul style="list-style-type: none"> <li>▪ Engines give off carbon monoxide.</li> <li>▪ Do not run the machine indoors or in enclosed areas.</li> <li>▪ NEVER operate in houses or garages, EVEN IF doors and windows are open.</li> <li>▪ Only use OUTDOORS and away from windows, doors and aeration.</li> <li>▪ Read through the operator's manual.</li> <li>▪ No sparks, flames or burning objects are permitted near the machine.</li> <li>▪ Stop the engine before refueling.</li> </ul>
3		Warning against hot surface.
4		<p>Warning against hot surface. PE = Potential grounding - Connect cable from grounding rod here (where required). <b>WARNING!</b> Electric shock will cause serious injury or death.</p>

## **5. Standard package**

The standard package includes:

- Equipment.
- Operator's manual.
- CE declaration

## 6. Lifting and transporting

### Lifting the machine

This compact generator is heavy enough to cause injury in the event of incorrect hoisting technology. Observe the following instructions to lift the generator:

- Do not try to lift the generator without help. Use suitable lifting bars e.g. loops, chains, twisting hooks, ramps or car jacks.
- Make sure that the lifting bars are firmly attached and have sufficient carrying capacity to safely lift or hold the generator.
- Pay attention to surrounding persons when lifting the generator.

### Transporting the machine

Observe the following instructions when the generator is transported from and to the construction site.

- Allow the engine to cool off before refueling the generator.
- Empty the fuel tank.
- Close the fuel cock.
- Firmly fasten the generator to the transport vehicle so that it does not slide or tip over.
- Do not refuel the generator in or on the transport vehicle. Transport the generator to the work location first and refuel the fuel tank there.
- Do not operate the genset in / on transport vehicle

## 7. Operation

### 7.1 Prepare the machine for first-time application

#### Prepare the machine for first-time application:

1. Ensure that all loose packaging material has been removed from the machine.
  2. Check the machine and its components for damage. Do not operate the machine if you find visible damage! Ask the PRAMAC dealer for advice at once.
  3. Check whether all of the parts belonging to the machine have been delivered and whether all loose parts and fasteners are present.
  4. Now attach components that are not yet fastened.
  5. Fill fluids as needed, including fuel, engine oil and battery acid.
  6. Bring the machine to its site of operation.
  7. Follow the wheel kit assembly instructions if present
- 



#### **DANGER**

##### **Carbon monoxide.**

The application of a generator in buildings can LEAD TO DEATH WITHIN MINUTES. The exhaust fumes from the generator contain carbon monoxide (CO). This is an invisible odorless poison. If the exhaust fumes of the generator can be smelled, CO is being inhaled. Even if no exhaust fumes can be smelled, CO could still be being inhaled.

- NEVER use the generator in buildings, garages, crawl spaces or other partially enclosed areas. Carbon monoxide can build up to deadly levels in these areas. A fan or open window does NOT provide sufficient fresh air.
  - ONLY use generators outdoors and far away from windows, doors and aeration. These openings can draw in generator exhaust fumes.
  - CO can penetrate into a home, even if a generator is used properly. ALWAYS use a battery-powered or battery-backup CO alarm in the home.
  - IMMEDIATELY get to fresh air if you feel unwell, dizzy or weak after using the generator. Consult a physician. It could be carbon monoxide poisoning.
- 

#### **Use of gasoline / ethanol mixtures**

This portable generator may not be used with gasoline / ethanol mixtures with more than 10% ethanol content.

## 7.2 Accessories Installation (only for P7500i)

### Remove accessories

Remove the attachment, remove the generator and attachment box from the packing box, and count the number of attachment according to the following table.

No.	Name	Quantity
1	Wheel	2
2	Axle	1
3	B pin	2
4	Washer	2
5	Bolt	8
6	Frame shock absorber bracket (left)	1
7	Frame shock absorber bracket (right)	1

### Wheel kit installation

Tool requirements: 12 mm wrench, 10 mm wrench, crosshead screwdriver used for battery wiring and clamp.



#### WARNING

It is strictly forbidden to run the generator when the wheel kit is not installed. The wheel kit provides air flow space between the ground and the inlet of generator.



#### WARNING

If the wheel kit is not installed, dust and debris may be sucked into the duct of generator, which will cause damage to the generator. Be sure to run the generator after the wheel kit is installed.

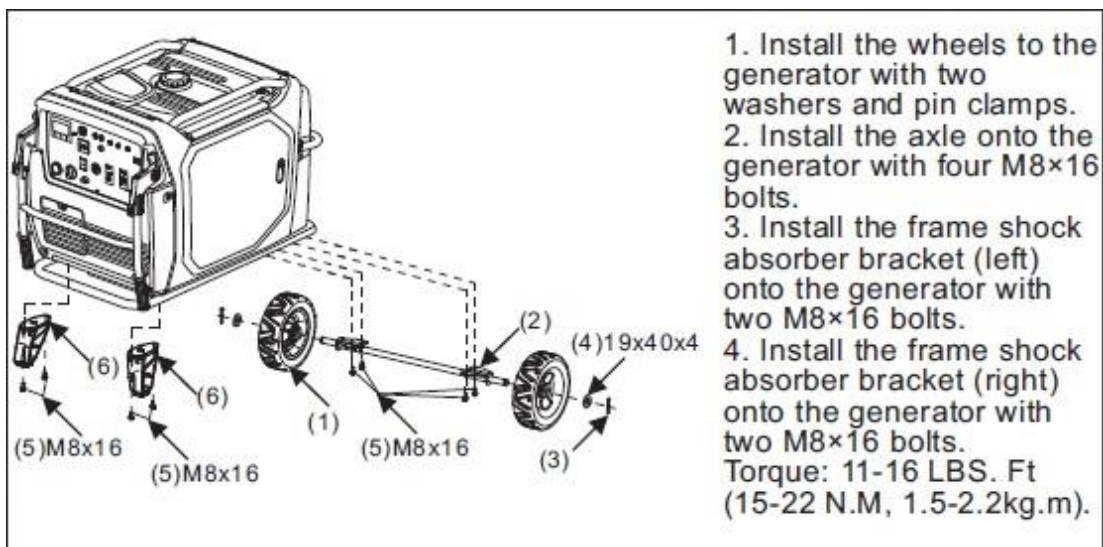

### 7.3 Power requirements

The singlephase PRAMAC generators are designed for the operation of singlephase 50 Hz electric devices for 230 VAC.

The threephase generators are designed for the operation of single-phase 50 Hz electric devices for 230 VAC and/or triple-phase 50 Hz electric devices for 400 VAC. The single-phase or triplephase sides can be used at the same time.

**NOTE:** Do not exceed the performance limit of the generator, as this may lead to damage of the generator or the tools. See Technical Data.

Check the nameplates or labels of the tools and electric equipment to be connected to ensure that the current values conform with those of the generator. Always inquire with the manufacturer if equipment is lacking the wattage.

Some electrical equipment requires more power to start than to operate. The generator must be able to provide this power. Some equipment actually requires more current than specified on the nameplate.

The "General power requirements for starting" information only applies as a general guideline to assist you in determining the power requirements. The nearest PRAMAC dealer, tool manufacturer can help you if you have questions.

**NOTE:** Do not exceed the specified current limit at any plug receptacle.

**NOTE:** If a tool or electrical equipment should not reach the full RPM a few seconds after starting, switch it off immediately in order to prevent damage.

#### General power requirements for starting

- White light bulbs and electronic goods, such as irons and hot plates, use a resistor heating element and require the same amount of power during startup that is listed on the nameplate.
- When starting, neon and mercury lamps require 1.2-2 times the specified wattage.
- Many electric motors and power tools use a large amount of power when starting. The electrical supply required during start-up depends on the type of motor and the intended application.
- When starting, most power tools require 1.2-3 times the specified wattage.
- Connection units, such as submersible pumps and air compressors, require a large amount of power when starting, even up to 3-5 times the specified wattage.

If the wattage of a tool or electrical equipment is not specified, this can be calculated by multiplying the voltage requirements with the amperage requirements.

Single-phase: VOLTS x AMPS = WATTS

Three-phase: VOLTS x AMPS x 1.732 x 0.8 = WATTS



#### 7.4 Performance loss with high altitude application

Generators run differently due to altitude and temperature differences. Unmodified internal combustion engines have reduced performance at high altitudes due to the lower air pressure. This means less performance and therefore a reduced power exploitation. As soon as temperatures increase, an engine runs less economically and electrical components have more resistance.

For every 300 meters above high altitudes of 1500 meters above sea level, the performance of the generator is reduced by 3.5%. For outside temperatures above 40 degrees Celsius, the generator performance is reduced by 3% for every additional 5 degrees. The tables shown help with the high altitude and outside temperature performance devaluation. In order to determine the true generator performance, it may be necessary to consider both the high altitude and temperature devaluation factors.

Outside temperature °C	Devaluation	Factor
45	3 %	0.97
50	6 %	0.94
55	9 %	0.91
60	12 %	0.88

High altitude m	Devaluation	Factor
1800	3.5%	0.965
2100	7%	0.93
2400	10.5%	0.895
2700	14%	0.86
3000	17.5%	0.825
3300	21%	0.79
4000	24.5%	0.755

## 7.5 Ground



### CAUTION

The mid-point (neutral) conductor of this equipment is not grounded. **Do not drive the PE rod into the ground under normal operating conditions.**

Refer to the local regulations if the equipment is intended to power a building or similar system.



For generator sets that are to supply a facility in a TT network, or if residual current protection is required in the TT network, or if this equipment must be used for additional protection due to conditions or regulations, only 30 mA residual current protective switches may be used as protective devices. The 30 mA residual current protective switch must be installed ON the generator set itself, but at least on the nearest possible position in relation to the generator set. Only with this type of installation is it allowed and necessary to establish the ground connection of the generator framework via the point provided on the frame (see ground symbol 5019).

## 7.6 Heavy duty operation

Do not operate this generator for longer than 20-30 minutes under maximum electrical load rating. For continuous operation, do not exceed the continuous (prime) power output of the generator. See technical data of the generator in this operator's manual.

## 7.7 Installation

Set up the generator so it is protected from rain, snow or other forms of moisture. The ground must be solid and level in order to prevent slipping or displacement. Do not direct the engine exhaust to an area with people.

Both the work area as well as the components must be protected from all forms of moisture.

## 7.8 Use of extension cables

A loss of power takes place when connecting electrical equipment or a tool to the generator with an extension cable — the longer the cable, the greater the loss of power. This means that less voltage is conveyed to the electrical equipment and the input current is increased or the performance is reduced. A larger extension cable diameter reduces the loss of voltage.

**NOTE:** Operation of electrical equipment under low voltage may lead to overheating.

The table serves as a guideline for selecting the correct cable size.

Only tough, rubber-sheathed flexible cables in accordance to regulation IEC 60245-4 or equivalent can be used.



### **WARNING**

Damaged cables may cause electric shock, which can lead to serious injury or death. NEVER use worn, bare or frayed cables. Replace damaged cables immediately.

Never exceed the cable's rated power.

Contact the cable manufacturer if you have questions about using the cable.

Select the cable size from the table *Minimum cross-section of extension cables* or calculate the minimum cross-section using the graph *Minimum cross-section of extension cables*. The X-axis of the graph stands for the values A x m (ampere x meter). The Y-axis stands for the cross-section in mm<sup>2</sup>. Multiply the steady state (operating) current for the load in ampere (A) with the desired length of the extension cable in meters (m). Now look for your result on the X-axis. Go along the graph until you have found the point for your field of application. Now read the recommended minimum cable length on the Y-axis.

### Example

For example, if there is a triple-phase application with 400 V of steady state (operating) current available for the load at 15 A and the desired extension cable length is 100 m, then:

$$15 \text{ A} \times 100 \text{ m} = 1500 \text{ A} \times \text{m}.$$

$$1500 \text{ A} \times \text{m} = 2.5 \text{ mm}^2.$$

Table for extension cable minimum size

Ampere - performance variable	Extension cable minimum size							
	230V/1~/50Hz				400V/3~/50Hz			
	Length in m				Length in m			
	25	50	100	200	25	50	100	200
Cross-section surface in mm <sup>2</sup>								
2	1.5	1.5	1.5	1.5	1.5	1.5	1.5	1.5
4	1.5	1.5	1.5	2.5	1.5	1.5	1.5	1.5
6	1.5	1.5	1.5	4	1.5	1.5	1.5	2.5
8	1.5	1.5	2.5	6	1.5	1.5	1.5	2.5
10	1.5	1.5	4	6	1.5	1.5	1.5	4
15	1.5	2.5	4	10	1.5	1.5	2.5	6
20	1.5	4	6	16	1.5	1.5	4	6
30	2.5	4	10	25	1.5	2.5	6	10
40	4	6	16	---	1.5	4	6	---

Diagram for extension cable minimum size

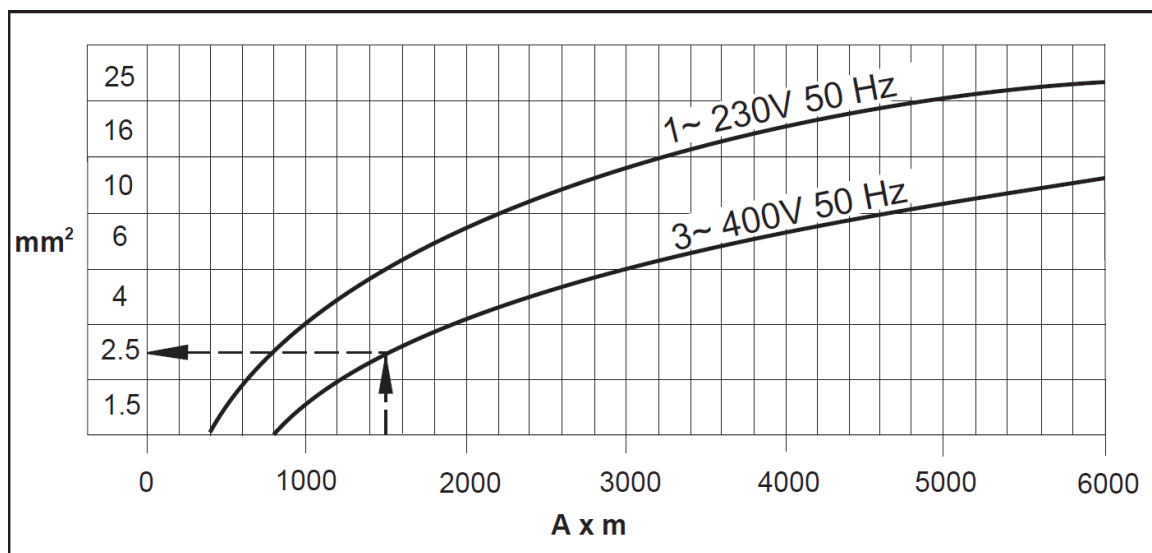

## 7.9 Control Panels

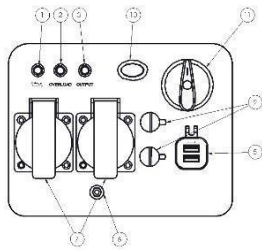

**P3000i**

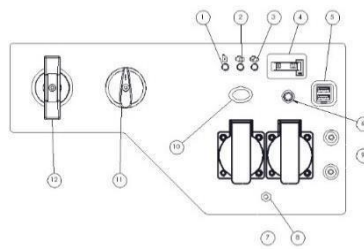

**P3500i/O**

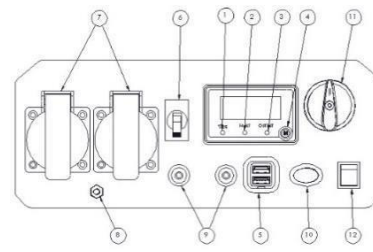

**P3500i**

1. Oil Warning Light
2. Overload Indicator Light
3. AC Pilot Light
4. Hourmeter / Page display /
5. USB Outlets
6. AC breaker
7. AC Outlets: this socket is only corresponding to a market, the different laws and regulations according to the sales area changes corresponding to the socket.
8. Ground Terminal
9. Parallel Outlets
10. Economy Throttle
11. Off / Run / Choke switch
12. Recoil starter / Electric starter

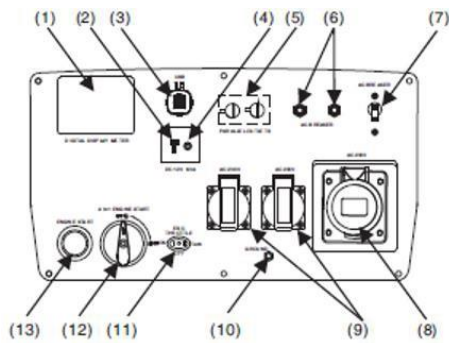
**P7000i**

1. Digital display meter
2. DC Outlet
3. USB Outlets
4. DC PROTECTION
5. Parallel outlets (with parallel unit)
6. AC breaker
7. AC breaker
8. AC Outlets: this socket is only corresponding to a market, the different laws and regulations according to the sales area changes corresponding to the socket.
9. AC Outlets: this socket is only corresponding to a market, the different laws and regulations according to the sales area changes corresponding to the socket.
10. Grounding terminal
11. Esc throttle
12. 4 in 1 Engine start
13. Engine start

## 7.10 Control Functions

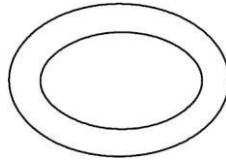

Throttle

### Throttle

When the Throttle switch is in the “I” position the throttle controls the engine speed according to the connected electrical load. The results are better fuel consumption and less noise. When the switch is in the “O” position the engine runs at 4,500 rpm regardless of the electrical load.

**NOTE:** The Throttle must be “O” when using electrical devices that require a large starting current, such as a compressor, pump, or refrigerator.

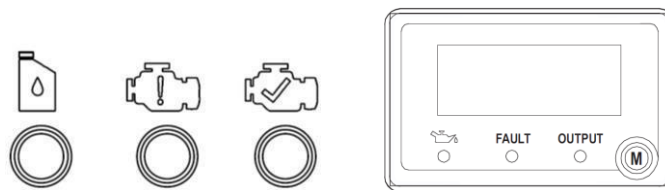

### Led Indicators

The LED Indicators assist in communicating proper and improper functions of the unit.

#### Output Indicator (Green)

The Output Indicator comes on when the engine starts and produces power.

#### Overload Alarm (Red)

The Overload Alarm comes on when a connected device requires more power than the generator is able to produce, the inverter control unit overheats, or the AC output voltage rises above rated values. The Output Indicator (Green) will go off and the Overload Alarm (Red) will stay on, but the engine will continue to run.

When the Overload Alarm Light comes on and power generation stops, proceed as follows:

1. Turn off any connected electric devices and stop the engine.
2. Reduce the total wattage of connected electric devices within the rated output.
3. Check for blockages in the cooling air inlet and around the control unit. If any blockages are found remove them.

4. After checking, restart the engine.

**NOTE:** The Overload Alarm may come on for a few seconds when first using electrical devices that require a large starting current, such as a compressor, pump, or refrigerator. This is normal behavior it is not a malfunction.

### Low Oil Alarm (Red)

When the engine oil falls below the required level the Low Oil Alarm will come on and the engine will stop automatically. The engine will not restart until oil is added to the unit to bring it up to the appropriate level.

**NOTE:** When starting the unit, if the Low Oil Alarm light flickers and the engine will not start, you will need to add engine oil before attempting to restart the engine.

**NOTE:** Generator should only be operated on a level surface. DO NOT operate the generator on loose ground or obvious inclines. The low oil shutdown feature may be prematurely activated in these cases causing the engine to not start.

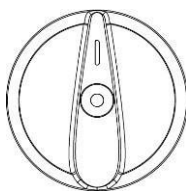

### Off / Run / Choke switch

The Engine Switch controls the ignition switch. The switch must be in the "I" position to start the generator. Switching to the "O" position stops the engine and will not allow the engine to be restarted.

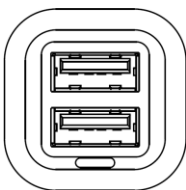

### USB Outlets

The 5 VDC, 1/2.1 Amp USB outlet allows charging of compatible electronic devices.



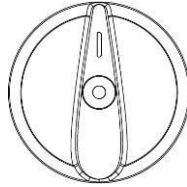

### Off / Run / Choke switch

The Off / Run / Choke switch controls the flow of gasoline from the fuel tank to the carburetor. The switch should be in the “I” position when starting and operating the generator. The switch should be in the “O” position when the engine is not running and when storing or transporting the unit.

**NOTE:** The Off / Run / Choke switch helps to prevent stale fuel from remaining in the carburetor while storing or transporting the unit. Run the fuel out by turning the knob to the “O” position and letting the engine run until it stops.

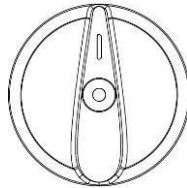

### Choke

The Choke position on Off / Run / Choke switch is used when starting the engine “cold” (the engine is not hot).

**NOTE:** Choke is not required to start a warm engine.

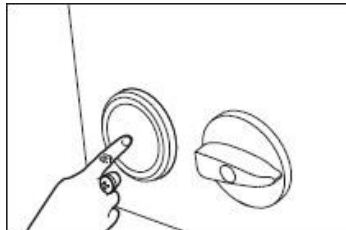

### One-key start switch (where available)

When the combination switch is placed in the “On” position, operate the start switch button to start the engine.

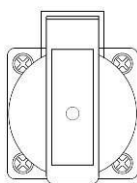

### 220/230/240V AC Outlets

The Outlets are used to power 220/230/240V Single Phase 50Hz loads requiring up to continuous power. This socket is only corresponding to a client, the different laws and regulations according to the sales area changes corresponding to the socket.

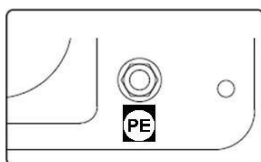

### Ground Terminal

The Ground (Earth) terminal is used to ground the generator when grounded electrical devices are being used. Consult an electrician for local grounding regulations.

### Parallel Connection within 2 generator

See the parallel Kit Operator's Manual

**NOTE:** All connections to parallel kit should be made while both inverters are turned off and loads disconnected

1. Make sure the Economy throttle is in the same position on both generators
2. Make appropriate parallel connections to the outlets on each inverter as outlined in the owner's manual supplied with the kit.

**NOTE:** Do not disconnect any parallel kit connections once the units are running

3. Start both units per starting instructions. Once the green output indicator illuminates, devices can be connected and turned on using the parallel kit outlet.
4. Follow **Stopping the engine** instructions

**NOTE:** Only use Pramac approved parallel kit

## 7.11 Before starting



### **DANGER** **Carbon monoxide.**

The application of a generator in buildings can LEAD TO DEATH WITHIN MINUTES. The exhaust fumes from the generator contain carbon monoxide (CO). This is an invisible odorless poison. If the exhaust fumes of the generator can be smelled, CO is being inhaled. Even if no exhaust fumes can be smelled, CO could still be being inhaled.

1. Read and understand the safety and operator's manual at the start of these operating instructions.
2. Read and understand all statements of the safety and warning signs.
3. Check:
  - Engine oil level.
  - Fuel level.
  - State of the air cleaner.
  - Tight fit of the outer bracket.
  - State of the fuel lines.

### **Adding engine Oil**

The generator has been shipped without engine oil. DO NOT add fuel or start the engine before adding engine oil.

**NOTE:** In order to add motor oil you will need to remove the side panel from the unit.

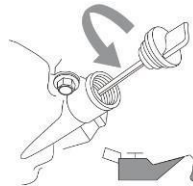

(Figure 2)

Place the generator on a level surface. DO NOT tilt the generator while adding oil. It can cause you to overfill the oil and/or cause the oil to leak into areas in which it is not intended.

Remove the oil filler cap (seen in figure 2).

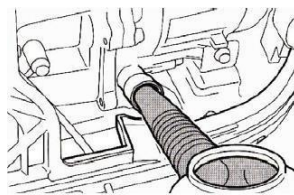

(Figure 3)

Using the funnel (provided) fill with 0.4 L of SAE 10W-30 or 10W-40 (provided) (see figure 3). See figure 4 for proper oil level.

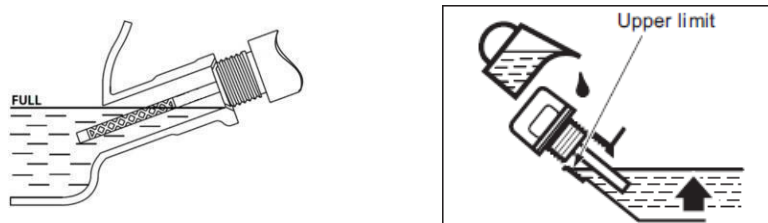

(Figure 4: left image for P3000i-P3500i-P3500lo, right image for P7500i)

Replace oil filler cap and secure side panel with screws.

**Recommended engine oil:**

- A. YAMALUBE4(10W-40) SAE10W-30 or 10W-40
- B. SAE #30
- C. SAE#20
- D. SAE#10W

Recommended engine oil grade: API Service SE type or higher

Engine oil quantity: see **Technical data**

**Adding Fuel**

The fuel tank capacity: see **Technical data**

DO NOT overfill the tank, otherwise it may overflow when the fuel warms up and expands.

**NOTE:** For safety reasons, once fuel has been added to this unit it cannot be returned to the place of purchase.

1. Use clean, fresh, regular unleaded fuel with a minimum octane rating of 87.
2. DO NOT mix oil with fuel.
3. Clean area around the fuel cap.
4. Remove the fuel cap.
5. Be sure that the fuel strainer is in place.
6. Slowly add fuel to the tank.
7. Do not exceed the red marker position of the fuel filter.
8. Screw on the fuel cap and wipe away and spilled fuel.

**NOTE:** Use only unleaded gasoline. The use of leaded gasoline will cause severe damage to internal engine parts.

After filling with fuel, make sure the fuel tank cap is tightened securely.

## 7.12 Starting the engine

OPERATE THE ENGINE IN A WELL VENTILATED AREA.

**DO NOT** connect any electrical devices to the outlets on the generator before starting the engine.

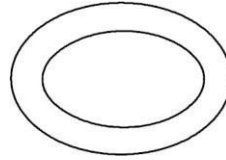

### 17.12.1 P3000i-P3500i-P3500i/O

1. Turn the Economy Throttle switch "O"

You may turn the Economy Throttle switch to "I" once the engine is started and a steady idle is achieved, (below 0°(32°F)/5mins, below 5°C(41 °F)/3mins.).

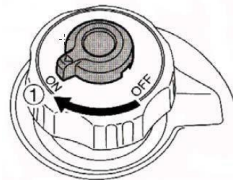

2. While holding the fuel tank cap so that it will not move, turn the air vent knob to "ON" (where available).

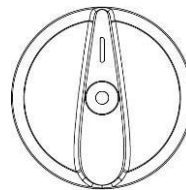

3. Turn the Off / Run / Choke switch to the "Choke" position.

**NOTE:** The Choke is not needed to start a warm engine. Push the knob in to the original position when starting the engine warm.

4. Grasp the carrying handle firmly to prevent the generator from falling over when pulling the recoil starter (where available)/press the start button (where available).
5. Pull slowly on the recoil starter (where available) until it is engaged and then pull it briskly.
6. After the engine starts, warm up the engine until the engine does not stop when the choke knob is returned the original position.

### 17.12.2 P7500i

1. According to the required voltage requirements, select the gear of voltage change-over switch.
2. Turn the switch to "On" position.

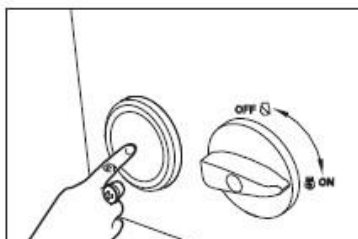

3. Press and release the start switch button. The start switch will start the motor for 5 seconds. When the engine starts successfully, the starter will stop automatically. If the engine does not start successfully, wait at least 10 seconds before starting again.

**NOTE:** Is it also possible to start the engine with the recoil starter:

1. Turn the lock 90° anticlockwise and open right maintenance door. Pull slowly on the recoil starter until it is engaged and then pull it briskly. Turn the lock 90° clockwise and close right maintenance door.

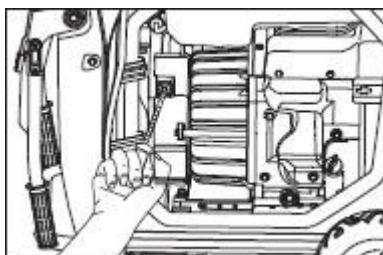

### 7.13 Stopping the Engine

Before stopping the engine turn off and disconnect any electronic devices attached to the generator.

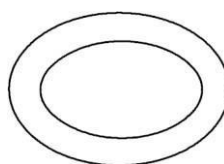

Turn the Throttle switch "O".

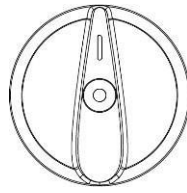

Turn the Off / Run / Choke switch to “O”.

## 8 Maintenance

### 8.1 Period maintenance schedule

The following table contains the basic maintenance jobs for the machine. Jobs selected with a check mark can be performed by the operator. The jobs marked with a small box require special training and special equipment.

	Daily before Operation	After the first month or 20 hours	Every 3 months or 50 hours	Every 6 months or 100 hours	Every year or 300 hours
Check the fuel level.	✓				
Check the engine oil level.	✓				
Check the air cleaner.	✓				
Check external fastening parts.	✓				
Clean air cleaner elements.*			✓	✓	
Check shockmount for damage.				✓	
Change the engine oil.*		▪		▪	
Check and clean spark plug.				▪	
Replace the spark plug.					▪
Clean the sediment cup.				▪	
Clean spark arrester.				▪	
Check and adjust valve clearance.					▪
Clean fuel tank and filter.*				▪	
Check the fuel line. Replace when necessary.					▪

\* Clean more often in dusty areas.



## 8.2 Engine Oil Replacement

Initial replacement of the engine oil is after one month or 20 hours of operation.

1. Place the generator on a level surface and warm up the engine for several minutes. Then stop the engine and turn the Off / Run / Choke switch to "O" and the Fuel Tank Cap Air Vent knob to "OFF".
2. Remove the screws and then remove the cover.
3. Remove the oil filler cap.
4. Place an oil pan under the engine. Tilt the generator to drain the oil completely.
5. Return the generator to a level surface.

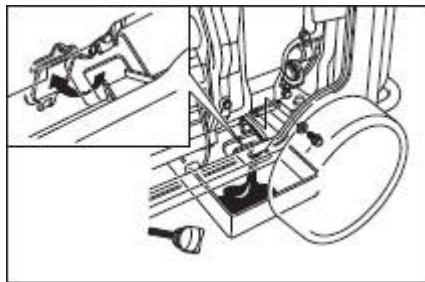

**NOTE:** DO NOT tilt the generator when adding engine oil. This could result in overfilling and damage to the engine.

6. Add engine oil to the upper level as seen in the figure 1.

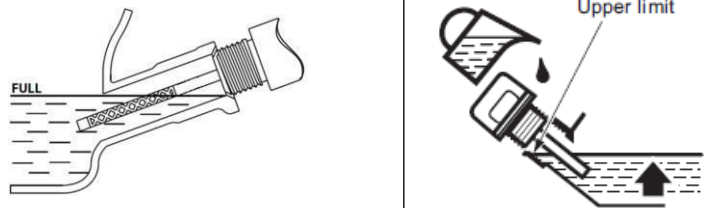

(Figure 1: left image for P3000i-P3500i-P3500Io, right image for P7500i)

**Recommended engine oil:** YAMALUBE4 (10W-40), SAE 10W-30 or 10W-40, SAE#30, SAE#20, SAE#10W.

**Recommended engine oil grade:** API Service SE type or higher

**Engine oil quantity:** see **Technical data**

7. Install oil filler cap, cover, and screws.

### 8.3 Air Filter Maintenance

Should be performed every 6 months or 100 hours. The air filter may need to be cleaned more frequently when using in unusually wet or dusty areas.

1. Remove the screw and then remove the cover.
2. Remove the bolt and then remove the air filter case cover.

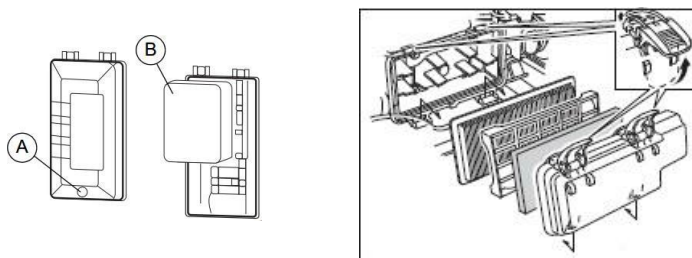

(Left image for P3000i-P3500i-P3500lo, right image for P7500i)

3. Remove the foam element.
4. Wash the foam element in solvent and dry it.
5. Oil the foam element and squeeze out excess oil. The foam element should be wet but not dripping.

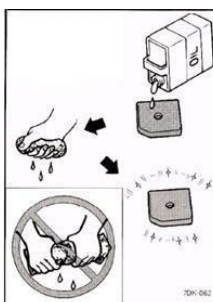

**NOTE:** Do not wring out the foam element when squeezing it. This could cause it to tear.

6. Insert the foam element into the air filter case. Be sure the foam element sealing surface matches the air filter so there is no air leak.

**NOTE:** The engine should never run without the foam element.

7. Install air filter case cover, cover, and screws.

### 8.4 Muffler Screen and Spark Arrestor Maintenance

Should be performed every 6 months or 100 hours. The air filter may need to be cleaned more frequently when using in unusually wet or dusty areas.

1. Remove the screws and then remove the cover.

- 
2. Remove the muffler cap, the muffler screen and spark arrester.

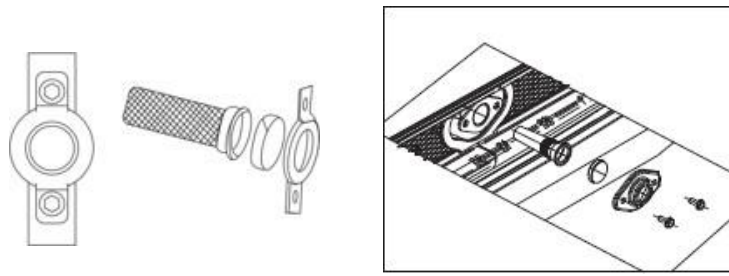

(Left image for P3000i-P3500i-P3500lo, right image for P7500i)

3. Remove the carbon deposits on the muffler screen and spark arrester using a wire brush. Use wire brush lightly to avoid damaging the muffler screen or spark arrester.

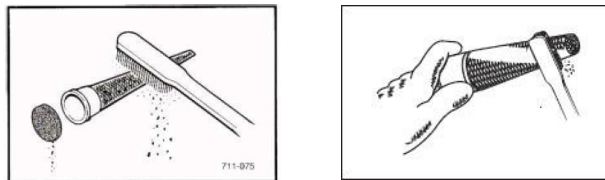

(Left image for P3000i-P3500i-P3500lo, right image for P7500i)

4. Check the muffler screen and spark arrester replace them if damaged.
5. Install the spark arrester.
6. Install the muffler cap.
7. Install the cover and tighten the screws.

### 8.5 Fuel Filter Maintenance (where available)

Should be performed every 12 months or 300 hours.

1. Remove the fuel tank cap and filter.
2. Clean the filter with gasoline.

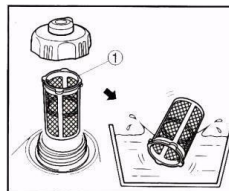

3. If damaged, replace it.
4. Wipe the filter and install it.
5. Install the fuel tank cap.



**WARNING**

**GASOLINE IS FLAMMABLE.** DO NOT perform this maintenance while smoking or near an open flame.

**8.6 Spark plug**

See image below.

Clean or replace the spark plug as needed. See engine manual.

**WARNING**

The exhaust will become very hot during operation and also remains hot for a while after the engine is switched off. Never touch a hot exhaust.

**Comment:** See the technical data for the recommended spark plug and spark plug air gap.

1. Remove and check the spark plug.
2. Replace the spark plug if the isolator is cracked or split.
3. Clean spark plug electrodes with a wire brush.
4. Adjust the spark plug air gap **(a)**.
5. Screw in and tighten the spark plug.

**NOTE:** A loose spark plug can become very hot and lead to engine damage.

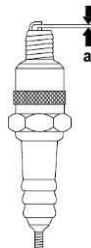
**8.7 Battery****Remove battery (where available)**

Battery terminals, wiring terminal and associated accessories containing lead and lead compounds. Wash hands immediately after handling.

- a. Lift handle up, lock handle and fix it in place.
- b. Loosen the bolts of maintenance cover and remove the battery maintenance cover (1).
- c. Remove the negative (-) cable from the negative (-) terminal of the battery and then remove the positive (+) cable from the positive (+) terminal of the battery.

- d. Remove the battery band from the hook at the bottom of generator.
- e. Remove the battery from the mounting box.

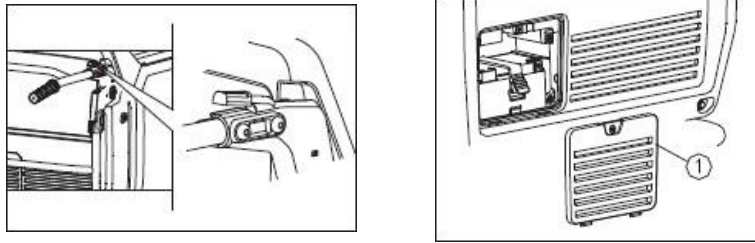

### Install the battery (where available)

Battery terminals, wiring terminal and associated accessories containing lead and lead compounds. Wash hands immediately after handling.

1. Put the battery in the mounting box.
2. Connect the positive (+) cable with the positive (+) terminal of the battery, tighten the bolt and cover the rubber cap.
3. Connect the negative (-) cable with the negative (-) terminal of the battery and tighten the installation bolt.
4. Install the battery band.
5. Reinstall battery maintenance cover and tighten the bolts. In the case that the battery maintenance cover is not assembled, it is strictly prohibited to run the generator, otherwise the performance of the generator and the engine will become poor.

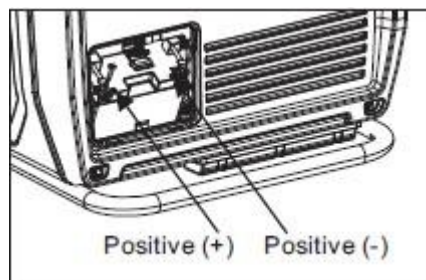

### NOTE:

- Be sure the ESC is turned off while charging the battery.

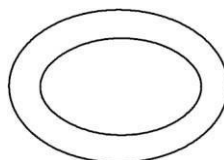

- Be sure to connect the red battery charger lead to the positive (+) battery terminal, and connect the black lead to the negative (-) battery terminal. Do not reverse these options.
  - Connect the battery charger leads to the battery terminals securely so that they are not disconnected due to engine vibration or other disturbances.
- 

**WARNING**

Batteries produce explosive gases.  
Sparks may ignite the battery gas.  
Avoid contact with skin, eyes or clothing.  
Keep out of reach of children.

---

**WARNING**

Battery electrolyte is poisonous and dangerous, causing severe burns, etc. contains sulfuric (sulphuric) acid.  
Avoid contact with skin, eyes or clothing.

---

## 8.8 Long Term Storage

Long term storage of your machine will require some preventive procedures to guard against deterioration.

**Drain the fuel**

1. Turn the Engine switch to "O".
  2. Remove the fuel tank cap. Extract the fuel tank into an approved gasoline container using a commercially available hand siphon. Then, install the fuel tank cap.
- 

**WARNING**

**GASOLINE IS FLAMMABLE.** DO NOT perform this maintenance while smoking or near an open flame.

---

**WARNING**

**Immediately wipe off spilled fuel with a clean, dry, soft cloth, since fuel may deteriorate painted surfaces or plastic parts.**

3. Turn the Engine switch to "I".
4. Turn the fuel tank cap air vent knob to "ON" (where available) and Off / Run/ Choke switch to "I"
5. Start the engine and let it run until it stops. Duration of the running engine depends on the amount of the fuel left in the tank.
6. Remove the screws, and then remove the cover.

- 
7. Drain the fuel from the carburetor by loosening the drain screw on the carburetor float chamber.
  8. Turn the Off / Run / Choke switch to "O"
  9. Tighten the drain screw.
  10. Install the cover and tighten the screws.
  11. Turn the fuel tank cap air vent knob to "OFF" (where available)
  12. Store the generator in a dry, well-ventilated place, with the cover placed over it.
- 

### **Engine**

Perform the following steps to protect the cylinder, piston ring, etc. from corrosion.

1. Remove the spark plug, pour about one table-spoon of SAE 10W-30 or 20W-40 motor oil into the spark plug hole and reinstall the speak plug. Recoil start the engine by turning over several times (with ignition off) to coat the cylinder walls with oil.
2. Pull the recoil starter until you feel compression. Then stop pulling, (this prevents the cylinder and valves from rusting).
3. Clean exterior of the generator and apply a rust inhibitor.
4. Store the generator in a dry, well-ventilated place, with the cover placed over it.
5. The generator must remain in a vertical position when stored, carried, or operated.



## 9 Basic troubleshooting

Problem / symptom	Cause / remedy
Check the following if the engine does not start:	<ul style="list-style-type: none"> <li>▪ Engine switch is in the "Start" position.</li> <li>▪ Fuel cock is open.</li> <li>▪ Fuel is replenished.</li> <li>▪ Choke lever is in the correct position. The choke should be closed when starting a cold engine.</li> <li>▪ No electric equipment is connected to the generator.</li> <li>▪ Spark plug is in good condition.</li> <li>▪ Spark plug cap is firmly seated.</li> <li>▪ Engine oil level is sufficient.</li> </ul>
Check the following if the engine starts, but the generator does not deliver any power to plug receptacles:	<ul style="list-style-type: none"> <li>▪ Fuse switch is closed.</li> <li>▪ Wiring from the generator to the plug receptacles is secured.</li> </ul>
Check the following if the engine starts, but runs irregularly:	<ul style="list-style-type: none"> <li>▪ Air cleaner condition.</li> <li>▪ Condition of the spark plug and spark plug cap.</li> <li>▪ How new the fuel is.</li> </ul>

## **10 Disposal**

### **10.1 Disposal of waste electrical and electronic equipment**

Professional disposal of this machine avoids negative effects on human health and the environment, helps with the targeted treatment of pollutants and makes it possible to recycle valuable raw materials.

#### **For customers in EU countries**

This machine is not affected by the European directive for old electrical and electronic equipment (Waste Electrical and Electronic Equipment (WEEE)). The WEEE directive provides the framework for an EU-wide treatment of old electrical equipment.

This unit is provided as a professional electrical tool exclusively for commercial use (a so-called B2B device according to the WEEE directive). Unlike equipment mostly used in private households (so-called B2C devices), this machine may therefore not be disposed of in some EU countries, such as in Germany, at the collection points of public waste management organizations (e.g. municipal collection stations). If there are any doubts, information regarding the different methods of disposal for B2B electronic devices for each country can be obtained from the sales location, so that the disposal takes place in accordance with the valid statutory provisions.

#### **For customers in other countries**

It is recommended that you do not dispose of the machine in normal household waste but rather in a separate, environmentally friendly collection facility. National laws also may, under certain circumstances, prescribe the separate disposal of electrical and electronic products. Correct disposal of this machine in accordance with current national guidelines must be assured.

## 11 Technical data

### 11.1 P3000i

Designation	Unit	P3000i
MAX Power	kW	2.52
COP Cont. Operating Power	kW	2.3
Length	mm	565
Width	mm	339
Height	mm	467
Weight	kg	27
<b>Engine</b>		
Combustion method		Four-stroke
Cooling		Air cooling
Cylinders		1
Displacement	cc	149
Fuel type		Gasoline
Fuel consumption @75%	l/h	1.1
Mixture preparation		Carburetor
Tank capacity	l	4.3
Max. oil filling	l	0.6
Spark plug type		E6RTC or equivalent
Spark plug air gap	mm	0.6-0.7
Starter type		Recoil hand starter
Output current	A	10
Output frequency	Hz	50
Phases	~	1
Plug receptacles		2xSCHUKO
Sound press. level L <sub>pA</sub> @7mt	dB(A)	62.8
Measured sound power level L <sub>wa</sub>	dB(A)	88
Guaranteed L <sub>wa</sub>	dB(A)	88

## 11.2 P3500i

Designation	Unit	P3500i
MAX Power	kW	3.0
COP Cont. Operating Power	kW	3.3
Length	mm	601
Width	mm	458
Height	mm	553
Weight	kg	49.5
<b>Engine</b>		
Combustion method		Four-stroke
Cooling		Air cooling
Cylinders		1
Displacement	cc	212
Fuel type		Gasoline
Fuel consumption@75%	l/h	1.7
Mixture preparation		Carburetor
Tank capacity	l	10
Max. oil filling	l	0.6
Spark plug type		F7RTC / BPR6ES or equivalent
Spark plug air gap	mm	0.6-0.7
Starter type		Recoil / Electric starter
Output current	A	13
Output frequency	Hz	50
Phases	~	1
Plug receptacles		2xSCHUKO
Sound press. level LpA @7mt	dB(A)	60.8
Measured sound power level Lwa	dB(A)	86
Guaranteed Lwa	dB(A)	86

**11.3 P3500i/o**

<b>Designation</b>	<b>Unit</b>	<b>P3500i/o</b>
MAX Power	kW	3.0
COP Cont. Operating Power	kW	3.3
Length	mm	490
Width	mm	430
Height	mm	417
Weight	kg	34
<b>Engine</b>		
Combustion method		Four-stroke
Cooling		Air cooling
Cylinders		1
Displacement	cc	212cc
Fuel type		Gasoline
Fuel consumption@75%	l/h	1.1
Mixture preparation		Carburetor
Tank capacity	l	9
Max. oil filling	l	0.6
Spark plug type		F7RTC / BPR6ES or equivalent
Spark plug air gap	mm	0.6-0.7
Starter type		Recoil hand starter
Output current	A	13
Output frequency	Hz	50
Phases	~	1
Plug receptacles		2xSCHUKO
Sound press. level LpA @7mt	dB(A)	68.5
Measured sound power level Lwa	dB(A)	94
Guaranteed Lwa	dB(A)	94

#### 11.4 P7500i

Designation	Unit	P7500i
MAX Power	kW	7.0
COP Cont. Operating Power	kW	6.5
Length	mm	950
Width	mm	765
Height	mm	77
Weight	kg	130
<b>Engine</b>		
Combustion method		Four-stroke
Cooling		Air cooling
Cylinders		1
Displacement	cc	420cc
Fuel type		Gasoline
Fuel consumption@75%	l/h	2.25
Mixture preparation		Carburetor
Tank capacity	l	25
Max. oil filling	l	1.45
Spark plug type		F7TC/F7RTC
Spark plug air gap	mm	0.7/0.8
Starter type		Electric start
Output current	A	30.5
Output frequency	Hz	50
Phases	~	1
Plug receptacles		2xSCHUKO + 1xCEE
Sound press. level L <sub>pA</sub> @7mt	dB(A)	65
Measured sound power level L <sub>wa</sub>	dB(A)	92
Guaranteed L <sub>wa</sub>	dB(A)	92

# 12 Diagram

## 12.1 P3000i

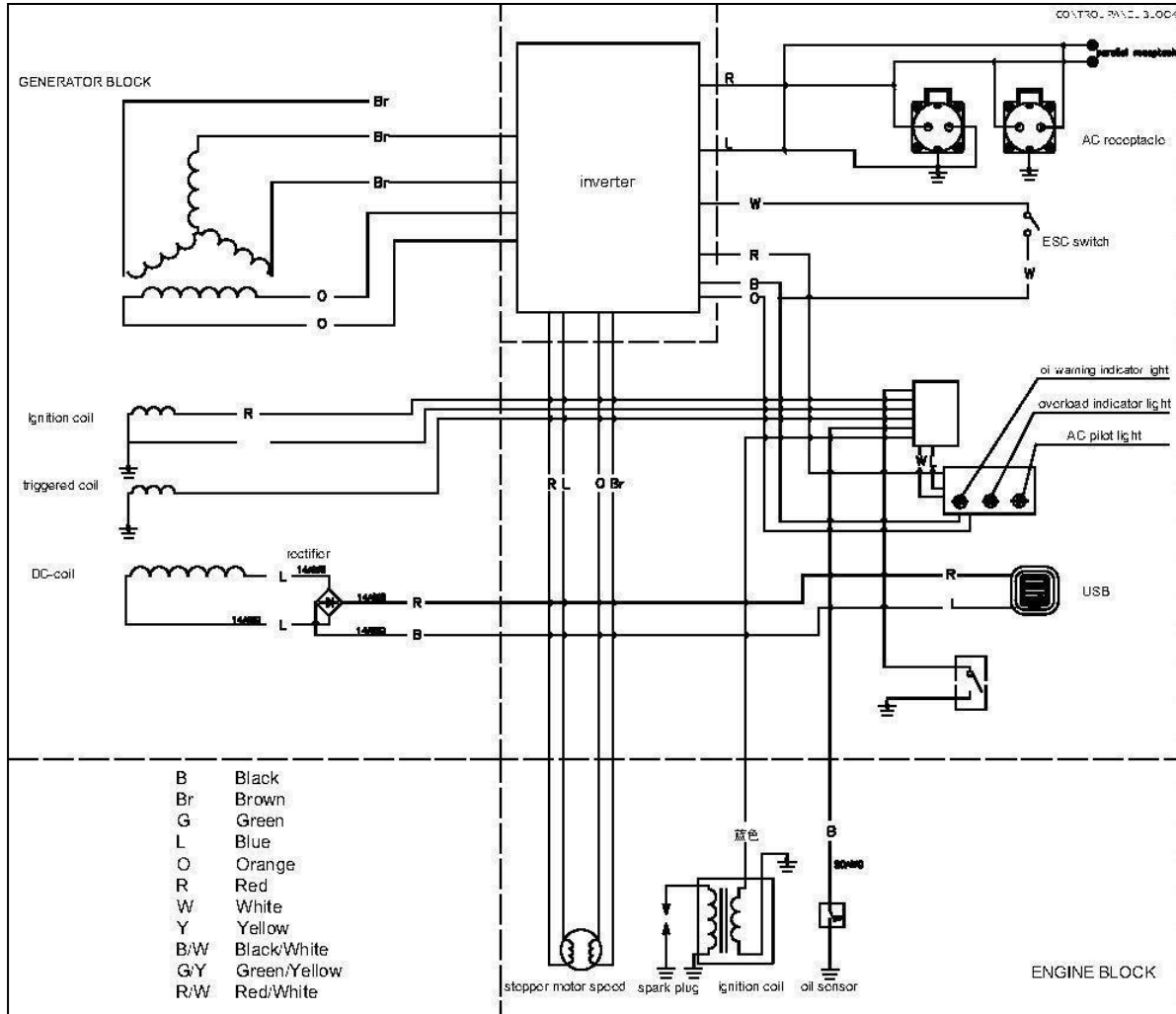

12.2 P3500i

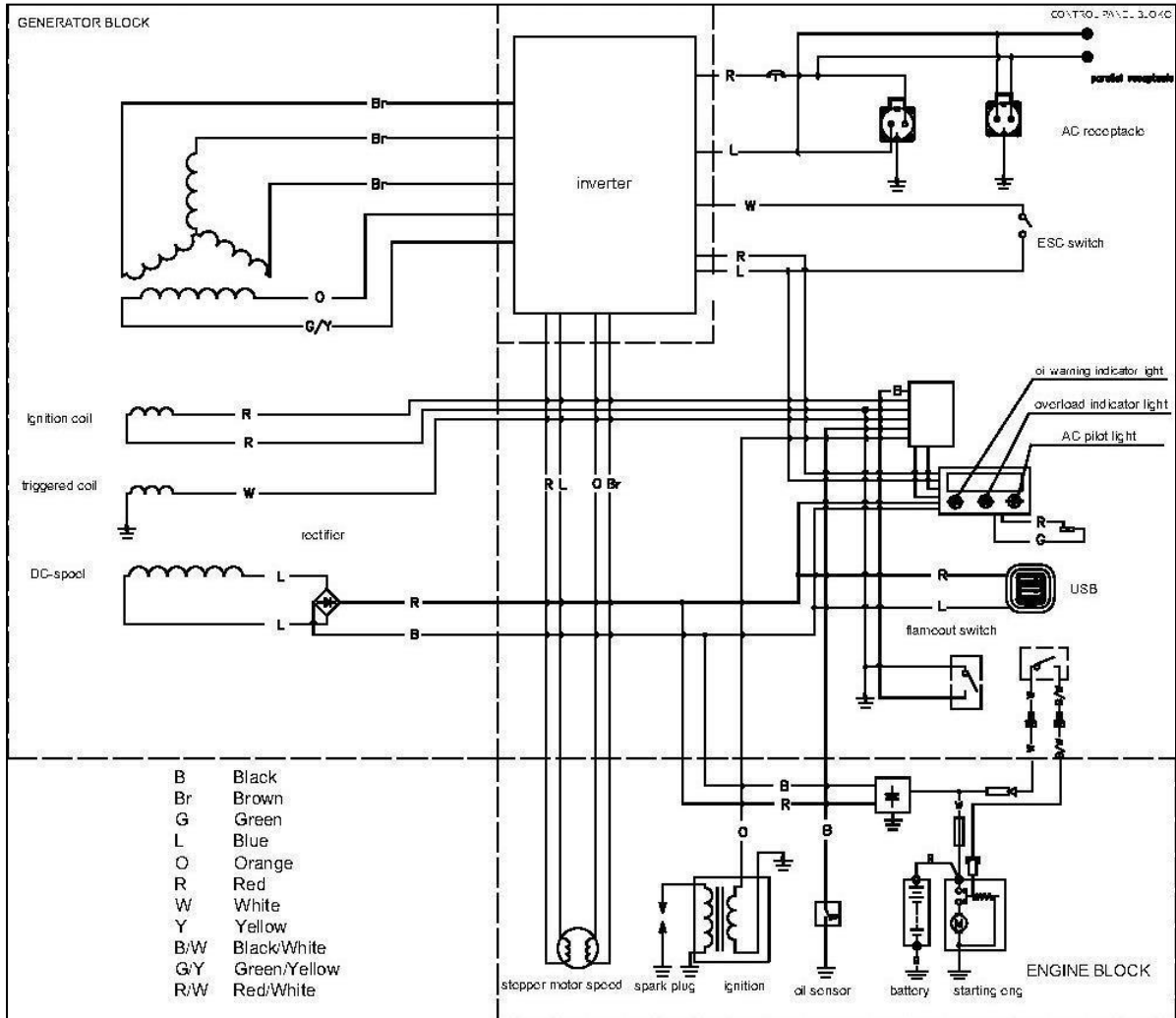



12.3 P3500i/o

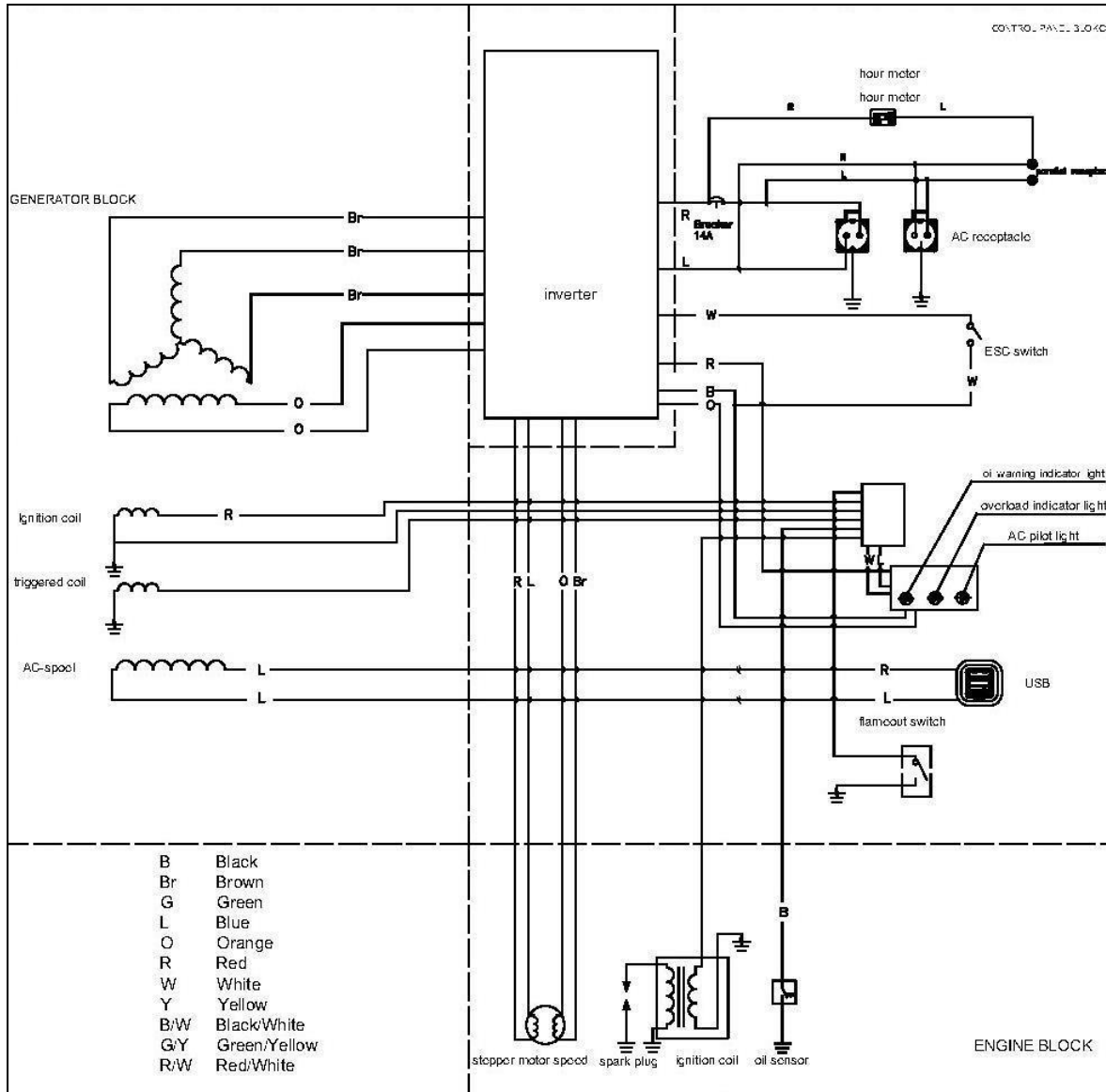

12.4 P7500i

